

Go to
www.vtechphones.com
to register your product
for enhanced warranty
support and the latest
VTech product news.

VC7151
VC7151-101
VC7151-109
VC7152-201
VC7152-301

Wireless Monitoring
System with
Cordless Telephone



vtech[®]
Abridged
User's manual

Congratulations

on purchasing your new VTech product. Before using this product, please read **Important safety instructions**.

This abridged user's manual provides you with basic operational instructions. A limited set of features are described in abbreviated form. For installation instructions, please refer to the **Installation Guide**.

Please refer to the online User's manual for a full set of installation and operation instructions at www.vtechphones.com. In Canada, visit www.vtechcanada.com.



Telephones identified with this logo have reduced noise and interference when used with most T-coil equipped hearing aids and cochlear implants. The TIA-1083 Compliant Logo is a trademark of the Telecommunications Industry Association. Used under license.

Register online to get an additional 3-month warranty!

Visit www.vtechphones.com.



Registration

Register your product online for enhanced warranty support.



Product news

Learn about the latest VTech products.

Table of Contents

| | | | |
|--|----|---|----|
| Introduction | 1 | Sensor log | 34 |
| What's in the box | 3 | Configure your telephone | 35 |
| Overview | 5 | Using the menu | 35 |
| Handset overview | 5 | Set language | 35 |
| Telephone base overview | 9 | Temporary tone dialing | 36 |
| Garage door sensor overview ... | 13 | Quiet mode | 36 |
| Open/closed sensor overview ... | 14 | Caller ID announce..... | 37 |
| Sensor unit overview | 14 | Use caller ID to automatically set date and time | 37 |
| Display icons overview | 15 | Telephone operations | 38 |
| Lights overview..... | 17 | Make a call | 38 |
| Handset battery | 19 | Answer a call | 38 |
| Before use | 20 | End a call..... | 38 |
| Set date and time | 20 | Handset speakerphone | 38 |
| Set answering system through voice guide..... | 20 | Volume..... | 39 |
| Check for dial tone..... | 21 | Mute..... | 39 |
| Operating range..... | 21 | Call waiting | 39 |
| Sensor | 22 | Find handset..... | 40 |
| Arm/Disarm the sensor alert system..... | 23 | Redial list | 40 |
| Sensor mode | 24 | Join a call in progress..... | 41 |
| Access an individual sensor menu | 27 | Push-to-talk (PTT) | 41 |
| Set alert schedule as always on..... | 28 | Intercom..... | 41 |
| Set a time range for alerts | 29 | Transfer a call | 42 |
| Turn off the alerts..... | 30 | Answer an incoming call during an intercom call..... | 42 |
| Alert notifications | 31 | Phonebook | 43 |
| Test sensor signal strength..... | 32 | Add a phonebook entry | 43 |
| Rename the sensor | 33 | Review and dial from the phonebook | 44 |
| Reset sensor alerts | 33 | Edit a phonebook entry | 44 |
| | | Delete a phonebook entry | 44 |

| | | | |
|--|-----------|--|-----------|
| Caller ID | 45 | Use your built-in answering system | 56 |
| Caller ID log..... | 45 | New message indication..... | 56 |
| Save a caller ID log entry to the phonebook..... | 46 | Message playback..... | 57 |
| Delete a caller ID log entry..... | 46 | Delete all old messages..... | 58 |
| Delete all caller ID log entries..... | 46 | Call intercept..... | 58 |
| Call block | 47 | Remote access | 59 |
| Block unknown calls..... | 47 | Listen to messages from remote access..... | 60 |
| Add a call block list entry..... | 47 | Change sensor mode from remote access..... | 61 |
| Review the call block list..... | 48 | Remote access code..... | 61 |
| Edit a call block list entry..... | 48 | Use the built-in answering system and voicemail service | 62 |
| Save a caller ID log entry to call block list..... | 48 | Retrieve voicemail from telephone service | 63 |
| Delete a call block list entry..... | 48 | Retrieve voicemail..... | 63 |
| Key tone..... | 49 | Set your voicemail number..... | 63 |
| Ringer tone..... | 49 | Turn off the new voicemail indicators..... | 64 |
| Ringer volume..... | 50 | Expand your telephone system | 65 |
| Temporary ringer silencing..... | 50 | ECO mode | 66 |
| About the built-in answering system and voicemail service | 51 | General product care | 66 |
| Set your built-in answering system | 52 | Storage | 66 |
| Turn the answering system on or off..... | 52 | Frequently asked questions | 67 |
| Default announcement..... | 53 | Limited Warranty | 70 |
| Record your own announcement..... | 53 | Technical Specifications | 73 |
| Play the announcement..... | 53 | Disclaimer | 74 |
| Reset the announcement..... | 54 | | |
| Set number of rings..... | 54 | | |
| Message alert tone..... | 55 | | |
| Recording time..... | 55 | | |
| Voice guide..... | 56 | | |

Introduction

This Wireless Monitoring System with VTech ULE consists of the telephone system, garage door sensor, open/closed sensor, and motion sensor. The telephone system is also sold separately or as:

- Telephone system and garage door sensor;
- Telephone system and open/closed sensor;
- A garage door sensor;
- An open/closed sensor; or
- A motion sensor.

Telephone system - Includes a telephone base and cordless handset (some models include additional handsets). The base and handset screens show call information and sensor alerts. The sensor sends alerts to the phone system or sends remote alert calls to other numbers you have specified.

Open/closed sensor - Apply this magnetic open/closed sensor to a door, window, or medicine cabinet to know if it is open or closed.

Garage door sensor - Detects when the garage door is open or closed.

Motion sensor - Lets you know when there are visitors, intruders, or pets moving around your home.

Sensor alert

When someone has arrived home, or you have forgotten to close the door, you will receive audible and text sensor alerts, for example, “*DOOR is open*”, on the handset and telephone base.

You can also program the phone system to make remote alert calls to up to three other telephone numbers. When you receive the remote alert call from the telephone base, you can choose to listen to the sound in your house; or you can choose to speak through the telephone base to the visitor or intruder. See pages 24 to 25.

Programmable alerts

Customize when and how you receive alerts.

When you receive alerts:

- A monitored garage door, in-house door, window, medicine cabinet opens, or there is motion in the monitored area;
- The monitored object is open for more than 15, 30, or 60 minutes if you have set a reminder for alerts;
- The monitored object is open, or a motion is detected, during a certain period of time if you have set a time range for alerts.

How you receive alerts:

- Audible and text sensor alerts on handset and telephone base;
- Receive a remote alert call on your cell phone or at other remote numbers you have programmed. See pages 24 to 25.

What's in the box

Your telephone package contains the following items. Save your sales receipt and original packaging in case it is necessary to ship your telephone for warranty service.



Telephone base



Telephone line cord

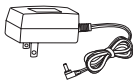

Telephone base adapter



Handset



Battery



Charger



Charger adapter

1 set for VC7151/VC7151-101/VC7151-109;
2 sets for VC7152-201;
3 sets for VC7152-301

1 set for VC7152-201;
2 sets for VC7152-301



Garage door sensor



Double-sided
mounting tape



Screw x 2

1 set for VC7151-101/
VC7151-109/
VC7152-201/
VC7152-301

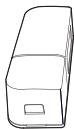

Open/closed
Sensor unit



Magnet unit

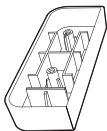

Spacer for
sensor unit

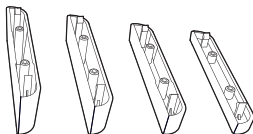

Spacers for magnet unit

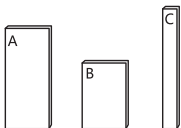

Double-sided
mounting tapes



Screw x 2



Small
screw x 2

1 set for VC7151-109

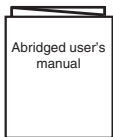

Abridged user's
manual



Installation guide



Important safety
Instructions

Overview

Handset overview

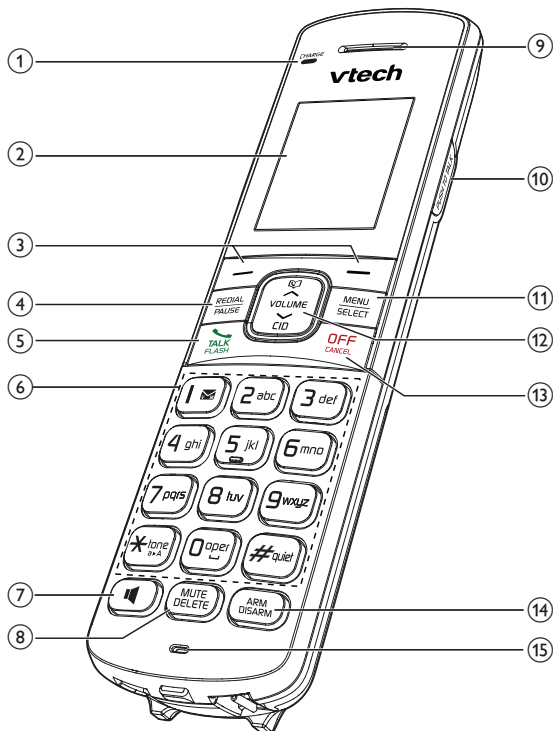

1 – CHARGE light

2 – LCD display

3 – Right Soft key

- Press to review the sensor status when the phone is not in use.
- While in a menu, press to select a menu item; or save an entry or setting.

Left Soft key

- Press to enter the sensor mode menu when the phone is not in use.
- Press to return to the previous menu.

4 – REDIAL/PAUSE

- Press repeatedly to review the redial list.
- Press and hold to insert a dialing pause while entering a number.

5 – TALK/FLASH

- Make or answer a call.
- Press to put the current call on hold when you receive an incoming call.
- Answer an incoming call when you hear a call waiting alert.

6 – Dialing keys

- Press to enter numbers or characters.

1

- Press repeatedly to add or remove **1** in front of the caller ID log entry before dialing or saving it to the phonebook.
- Press and hold to set or dial your voicemail number.

tone

- While you have set the dial mode to pulse and on a call, press to switch to tone dialing temporarily.

space

- Press to add a space when entering names.

#quiet

- Press and hold to enter quiet mode setting menu.
- Press repeatedly to show other dialing options when reviewing a caller ID log entry.

7 –

- Make or answer a call using the handset speakerphone.
- During a call, press to switch between the speakerphone and the earpiece.

8 – MUTE/DELETE

- Mute the microphone during a call.
- While editing names or numbers, press to delete a digit or character, or press and hold to delete all digits or characters.
- Delete the playing message on the handset.
- Silence the ringer temporarily while the handset is ringing.

9 – Earpiece

10 – PUSH TO TALK

- Press to display the **PUSH TO TALK** (PTT) menu to begin a PTT call when the phone is not in use.
- Press and hold to begin a one-to-group PTT call.
- Press and hold while talking in a PTT call.

11 – MENU/SELECT

- While in a menu, press to select an item; or save an entry or setting.

12 – VOLUME/

- Review the phonebook when the phone is not in use.
- Increase the listening volume during a call or message playback.
- Scroll up while in a menu, or in the phonebook, caller ID log, or redial list.
- Move the cursor to the right when entering numbers or names.

VOLUME/~/CID

- Review the caller ID log when the phone is not in use.
- Decrease the listening volume during a call or message playback.
- Scroll down while in a menu, or in the phonebook, caller ID log, or redial list.
- Move the cursor to the left when entering numbers or names.

13 – OFF/CANCEL

- Hang up a call.
- Silence the ringer temporarily while the handset is ringing.
- Press and hold to erase the missed call indicator while the phone is not in use.
- Press to return to the previous menu, or press and hold to return to idle mode, without making changes.

14 – ARM/DISARM

- Press to turn on or off the sensor alert system.

15 – Microphone

Telephone base overview

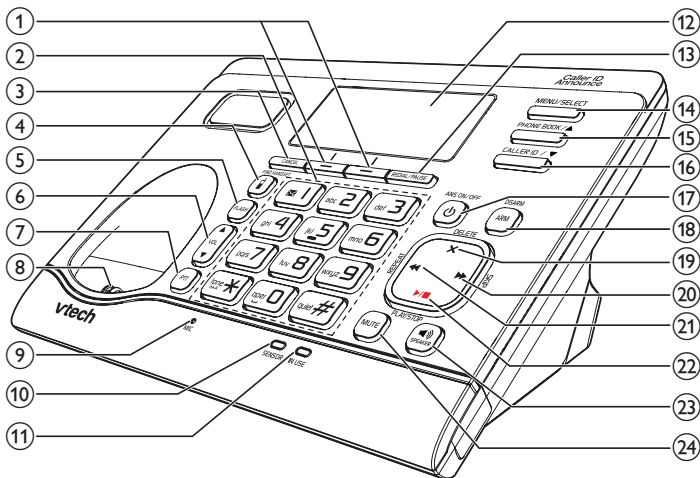

1 – Right Soft key

- Press to review the sensor status when the phone is not in use.
- While in a menu, press to select a menu item; or save an entry or setting.

Left Soft key

- Press to enter the sensor mode menu when the phone is not in use.
- Press to return to the previous menu.

2 – Dialing keys

- Press to enter numbers or characters.



- Press repeatedly to add or remove **1** in front of the caller ID log entry before dialing or saving it to the phonebook.
- Press and hold to set or dial your voicemail number.

***_{tone}**

- While you have set the dial mode to pulse and on a call, press to switch to tone dialing temporarily.

0_{oper}

- Press to add a space when entering names.

#_{quiet}

- Press and hold to enter quiet mode setting menu.
- Press repeatedly to show other dialing options when reviewing a caller ID log entry.

3 – CANCEL

- Silence the ringer temporarily while the telephone base is ringing.
- Press and hold to erase the missed call indicator while the phone is not in use.
- Press to return to the previous menu, or press and hold to return to idle mode, without making changes.

4 – /FIND HANDSET

- Press to page all system handsets.

5 – FLASH

- Press to put the current call on hold when you receive an incoming call.
- Answer an incoming call when you hear a call waiting alert.

6 – /VOL/

- Adjust the volume during a call or message playback.
- Adjust the telephone base ringer volume when the phone is not in use.

7 – PTT (Push to talk)

- Press to display the PTT menu to begin a PTT call.
- Press and hold to begin a one-to-group PTT call.
- Press and hold while talking in a PTT call.

8 – Charging pole

9 – MIC (Microphone)

10 – SENSOR light

- On when a sensor detects that one or more of the monitored garage door, in-house door, window, or medicine cabinet is opened, or when there is motion in the monitored area.

11 – IN USE light

- On when the telephone line is in use.
- On when the answering system is answering a call.
- On when you are registering a handset.
- Flashes quickly when there is an incoming call.
- Flashes quickly when you are deregistering all handsets.
- Flashes slowly when another telephone sharing the same line is in use.

12 – LCD display

13 – REDIAL/PAUSE

- Press repeatedly to review the redial list.
- Press and hold to insert a dialing pause while entering a number.

14 – MENU/SELECT

- While in a menu, press to select an item; or save an entry or setting.

15 – PHONEBOOK / ▲

- Review the phonebook when the phone is not in use.
- Scroll up while in a menu, or in the phonebook, caller ID log, or redial list.
- Move the cursor to the right when entering numbers or names.

16 – CALLER ID / ▼

- Review the caller ID log when the phone is not in use.

- Scroll down while in a menu, or in the phonebook, caller ID log, or redial list.
- Move the cursor to the left when entering numbers or names.

17 – /ANS ON/OFF

- Turn the answering system on or off.

18 – ARM/DISARM

- Press to turn on or off the sensor alert system.

19 – X/DELETE

- While editing names or numbers, press to delete a digit or character, or press and hold to delete all digits or characters.
- Delete the playing message.
- Press twice to delete all previously reviewed messages when the phone is not in use.

20 – /SKIP

- Skip to the next message.

21 – /REPEAT

- Press to repeat a message.
- Press twice to play the previous message.

22 – /PLAY/STOP

- Play messages.
- Stop playing messages.

23 – /SPEAKER

- Make or answer a call using the speakerphone.
- Hang up a call.

24 – MUTE

- Mute the microphone during a call.
- Silence the ringer temporarily while the telephone base is ringing.

Garage door sensor overview

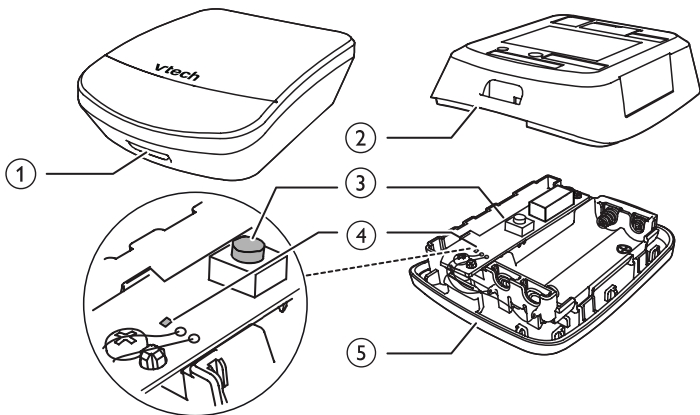

1 – Latch button

- Press to open the battery compartment case.

2 – Back cover

3 – Pair button

- When the sensor has been deregistered from the telephone base, press and hold to enter the registration mode.

4 – LED light

- Flashes red when the sensor is in the registration mode.

5 – Battery compartment case

Open/closed sensor overview

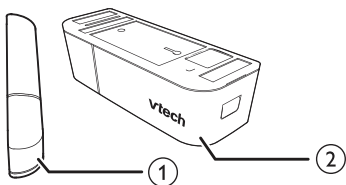

1 – Magnet unit

2 – Sensor unit

Sensor unit overview

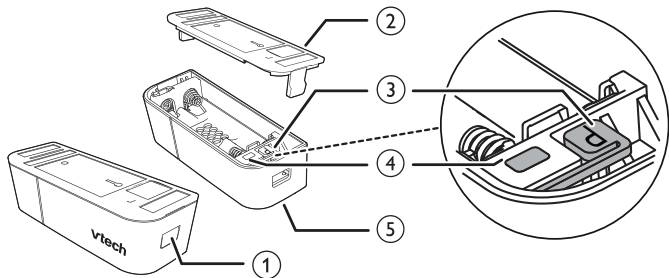

1 – Latch button

- Press to open the battery compartment case.

2 – Back cover

3 – Pair button

- When the sensor has been deregistered from the telephone base, press and hold to enter the registration mode.







4 – LED light





- Flashes red when the sensor is in the registration mode.

5 – Battery compartment case





Display icons overview





Handset icons

| | |
|---|--|
|  | Battery status - battery is charging (animated display). |
|  | Battery status - the battery icon flashes when the battery is low and needs charging. |
|  | Speakerphone - the handset speakerphone is in use. |
|  | Ringer off - the handset ringer is off. |
|  | New voicemail - you have new voicemail from your telephone service provider. |
| ANS ON | Answering system on - the answering system is turned on to answer calls. |
|  | Message - you have new message in the built-in answering system. |
|  | Search bar icon - appears when in the phonebook menu. |
| ECO | ECO mode - activates automatically to reduce power consumption when the handset is within range from the telephone base. |
| NEW | New caller ID log - displays in caller ID log when there are new missed calls. |
| MISSED | Missed alerts in sensor log - displays in sensor log when there are new missed alerts from sensors. |
| ##/## | Index - shows the entry number of the sensor status, or in the sensor log, phonebook, caller ID log, or call block list that is currently being viewed, out of the total number of entries. |

| | |
|---|--|
| MUTE | MUTE - the handset microphone is off. |
|  | Sensor - the garage door, in-house door, window, or medicine cabinet is opened. |
|  | Missed alerts in idle mode - displays in idle mode when there are new missed alerts from sensors. |
|  | Armed local mode - displays when the sensor alert system is turned on, and is set to receive alerts locally. Alerts are received on the telephone system only. |
|  | Armed remote mode - displays when the sensor alert system is turned on, and is set to receive alerts remotely. Alerts are received at the stored telephone numbers. |

Telephone base icons

| | |
|---|---|
|  | Ringer off - the telephone base ringer is off. |
|  | New voicemail - you have new voicemail from your telephone service provider. |
| ANS ON | Answering system on - the answering system is turned on to answer calls. |
|  | Message - you have new message in the built-in answering system. |
|  | Search bar icon - appears when in the phonebook menu. |
| ECO | ECO mode - activates automatically to reduce power consumption when the handset is within range from the telephone base. |
| NEW | New caller ID log - displays in caller ID log when there are new missed calls. |

| | |
|---|--|
| MISSED | Missed alerts in sensor log - displays in sensor log when there are new missed alerts from sensors. |
| ##/## | Index - shows the entry number of the sensor status, or in the sensor log, phonebook, caller ID log, or call block list that is currently being viewed, out of the total number of entries. |
| MUTE | MUTE - the telephone base microphone is off. |
|  | Sensor - the garage door, in-house door, window, or medicine cabinet is opened. |
|  | Missed alerts in idle mode - displays in idle mode when there are new missed alerts from sensors. |
|  | Armed local mode - displays when the sensor alert system is turned on, and is set to receive alerts locally. Alerts are received on the telephone system only. |
|  | Armed remote mode - displays when the sensor alert system is turned on, and is set to receive alerts remotely. Alerts are received at the stored telephone numbers. |

Lights overview

Handset lights

| | |
|--|---|
|  | On when the handset speakerphone is in use. |
| CHARGE | On when the handset is charging in the telephone base or handset charger. |

Telephone base lights

| | |
|----------------------|--|
| SENSOR | On when the garage door, in-house door, window, or medicine cabinet is opened. |
| IN USE | On when: <ul style="list-style-type: none">• the telephone line is in use;• the answering system is answering a call; or• you are registering a handset. Flashes quickly when: <ul style="list-style-type: none">• there is an incoming call; or• you are deregistering all handsets. |
| ⏻/ANS ON/OFF | On when the answering system is turned on. |
| MUTE | On when the telephone base microphone is muted. |
| ▶/■/PLAY/STOP | On when the answering system is playing a message. Flashes slowly when there is a new message. |

Sensor light

| | |
|------------------|---|
| LED light | On for five seconds when the sensor is successfully registered to the telephone base. Flashes slowly when the sensor is registering to the telephone base. |
|------------------|---|

Handset battery

Once you have installed the battery, the battery indicators show the battery status (see the table followed).

NOTES

- For best performance, keep the handset in the telephone base or charger when not in use.
- The battery is fully charged after 12 hours of continuous charging.

| Battery indicators | Battery status | Action |
|--|--|---|
| The screen is blank, or shows Place in charger and ⇨ flashes. | The battery has no charge or very little charge. The handset cannot be used. | Charge without interruption (at least 30 minutes). |
| The screen shows Low battery and ⇨ flashes. | The battery has enough charge to be used for a short time. | Charge without interruption (at least 30 minutes). |
| The screen shows HANDSET X . | The battery is charged. | To keep the battery charged, place it in the telephone base or charger when not in use. |

Before use

After you install your telephone, or power returns following a power outage, the telephone system will prompt you to set the date and time first. Then, it will ask you to set the answering system through voice guide.

Set date and time

- Make sure you set the date and time including the year correctly; otherwise the answering system does not announce the correct day of the week for your recorded messages time stamp.
1. Use the dialing keys (**0-9**) to enter the month, date, and year, and then press **NEXT** .
 2. Use the dialing keys (**0-9**) to enter the hour and minute.
 3. Scroll to choose **AM** or **PM**, and then press **SAVE** to save.

After the setting for the date and time, the screen will display **Start voice guide to set up Answering system now?**.

Set answering system through voice guide

This feature assists you to do the basic setup of the answering system. You can follow the voice guide to record your own announcement, set the number of rings and the message alert tone.

1. Press **YES** to start the voice guide for the answering system setup. You hear the voice prompt *"Hello! This voice guide will assist you with the basic setup of your answering system."*
2. Setup your answering system by inputting the designated numbers as instructed in the voice guide.

Check for dial tone

Press  or  on the handset, or  on the telephone base. If you hear a dial tone, the installation is successful.





If you do not hear a dial tone:

- Make sure the installation procedures described above are properly done.
- It may be a wiring problem. If you have changed your telephone service to digital service from a cable company or a VoIP service provider, the telephone line may need to be rewired to allow all existing telephone jacks to work. Contact your cable/VoIP service provider for more information.

Operating range

This cordless telephone operates with the maximum power allowed by the Federal Communications Commission (FCC). Even so, this handset and telephone base can communicate over only a certain distance - which can vary with the locations of the telephone base and handset, the weather, and the layout of your home or office.

When the handset is out of range, the handset displays **Out of range OR no power at base** and **Put HS on base to power base** alternately.

If there is a call while the handset is out of range; it may not ring, or if it does ring, the call may not connect well when you press  or . Move closer to the telephone base, and then press  or  to answer the call. If the handset moves out of range during a telephone conversation, there may be interference. To improve reception, move closer to the telephone base.

Sensor

The sensor helps you to monitor your garage door, in-house door, window, medicine cabinet, or an area around your house. This keeps you notified if the monitored object is open or closed, or someone has accessed an area that is off-limits.

When any of the monitored garage door, in-house door, window, or medicine cabinet opens, or when there is motion in the monitored area, the sensor sends an alert to your telephone. Both the base and handsets announce and display alert messages.

The telephone system has a sensor log. It stores the latest 50 alert messages from all sensors. You can review when and which sensor was triggered. You can also use the individual sensor's menu to check the current sensor status and sensor log.

You can choose to receive alert calls at other telephones. Store up to three desired telephone numbers, for example your cell phone number and office phone number, into the telephone base. You will be notified even when you are away from home. When you receive the remote alert call from the telephone base, you can choose to listen to the sound in your house; or you can choose to speak through the telephone base to the visitor or intruder.

Follow the instructions in this section to turn on or off the sensor alert system and change sensor mode; or to set sensor alert schedule, test the sensor signal strength, rename the sensor, reset sensor alerts, and review sensor logs.

NOTE

- When there are more than four handsets registered, the telephone system supports sensor alerts for the first four registered handsets only.

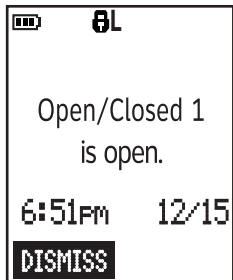

Arm/Disarm the sensor alert system

You can use the **ARM/DISARM** key on the handset or telephone base to turn on or off the sensor alerts immediately, by arming or disarming the sensor alert system.

To disarm the sensor alert system:

- When the sensor alert system is in armed mode, press **DISARM** on the handset or telephone base to turn off all sensor alerts.

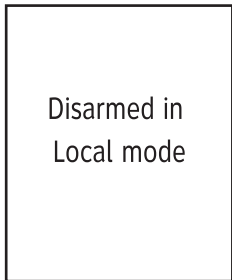

NOTE:

- The  icon will still display on the handset and telephone base. The **SENSOR** light on the telephone base will also remain on.



To arm the sensor alert system:

- When the sensor alert system is in disarmed mode, press **ARM** on the handset or telephone base to turn on the sensor alerts.

In idle mode, the handset and telephone base will display  when the current sensor mode is **Local**, or  when the current sensor mode is **Remote**.

NOTE:

- The sensor alert behavior depends on the current settings of individual sensor's alert schedule and the sensor notification type. Refer to the following sections for more information.

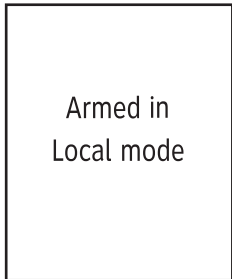

Sensor mode

You can choose **Local** mode to receive alerts at the telephone system, or **Remote** mode to receive calls at other numbers you have specified. This allows you to get notified even when you are away from home. The preset sensor mode is **Local**.

In **Remote** mode, when you receive the remote alert call, you will hear the alert message and then you can choose to listen to the sound in your house; or you can choose to speak through the telephone base to the visitor or intruder.

| | Receive alerts at the telephone system | Receive calls at up to 3 desired phones |
|--------|--|---|
| Remote | -- | ✓ |
| Local | ✓ | -- |

1. Press **MODE** on the handset or telephone base when idle.
2. Scroll to choose **Remote** or **Local**, and then press **SELECT** to select or save.
 - When **Remote** is chosen, and no telephone number has been previously set, you will be prompted to set the telephone numbers for remote calls.

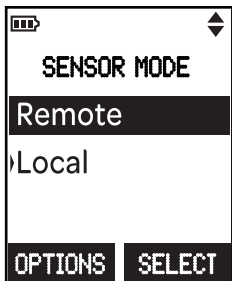

NOTES

- In **Remote** mode, the stored telephone numbers will ring in sequence. If the first telephone number is busy or does not pick up the remote call, the telephone system will call the second telephone number, and so on.

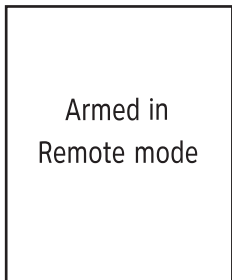

Edit numbers for remote calls:

You can add, edit, or delete a telephone number for remote calls.

1. Press **MODE** on the handset or telephone base when idle.
2. Scroll to choose **Remote**, and then press **OPTIONS**.
3. Press **SELECT** to select **Set tel number**.
4. Scroll to the desired slots (**1**, **2**, or **3**), and then press **SELECT**.
5. Use the dialing keys to enter the number.
6. Press **SAVE** to save.

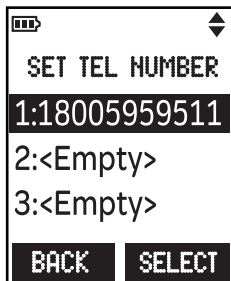

Set time delay for remote calls:

You can choose to set an exit or entrance delay time for the remote calls, so that when a sensor is triggered when you exit or enter your home within the delay time, you will not receive the unnecessary remote call.

For example, when you are about to leave home, you can set the exit delay time to **5 minutes**. Once the delay is set, you will not receive a remote call even when you open the door within those five minutes.

As for the entrance delay time, if you set it to **1 minute**, you will receive the remote call a minute after opening the door as you come home, unless you press **MODE** and then choose **Local** mode, or press **DISARM** on the handset or telephone base within that minute.

If you want to be notified immediately whenever a door is opened, we recommend you to set it as **0 minutes**.

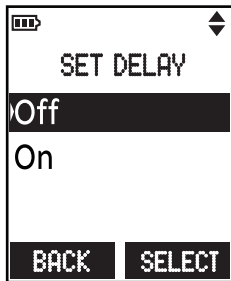

- At the last 10 seconds of exit delay time, there will be a beep every second.
 - When a delay time has been set, there will not be any local or remote call alerts when a monitored garage door, in-house door, window, or medicine cabinet is open, or when there is motion in the monitored area, during the delay time.
 - If you are not able to exit home before the delay time ends, you can restart the delay time again when you are ready to leave:
 - switch the sensor mode to **Local**, and then switch it back to **Remote**; or
 - press **DISARM** to switch the sensor alert system to **Disarmed**, and then press **ARM** to switch it back to **Armed**.
 - The delay time set will be activated when:
 - the sensor mode is switched to **Remote** from the **Armed-Local** mode; or
 - the sensor alert system is switched to **Armed** from the **Disarmed-Remote** mode.
1. Press **MODE** on the handset or telephone base when idle.
 2. Scroll to choose **Remote**, and then press **OPTIONS**.
 3. Scroll to choose **Set delay** and then press **SELECT**.
 4. Scroll to choose **On**, and then press **SELECT** to proceed to choose the exit delay time.
 - To skip time delay setting, scroll to choose **Off**, and then press **SELECT**.
 5. Scroll to choose **3 minutes**, **5 minutes** or **8 minutes**, and then press **SELECT** to proceed to choose the entrance delay time.
 6. Scroll to choose **0 minutes**, **1 minute** or **3 minutes**, and then press **SELECT** to save the delay time.

Access an individual sensor menu

The sensors menus appear when there is at least one sensor registered to the telephone base.

1. Press **SENSORS** on the handset or telephone base when idle, and then scroll to the desired sensor.

-OR-

- i. Press **MENU** when the phone is not in use.
 - ii. Scroll to **Sensors**, and then press **SELECT**.
 - iii. Scroll to the desired sensor, and then press **SELECT**.
2. Press **OPTIONS** to enter the individual sensor menu.
 3. Scroll until the screen displays the desired feature menu.
 4. Press **SELECT** to enter that menu.
- To return to the previous menu, press **CANCEL**.
 - To return to idle mode, press and hold **CANCEL**.

Set alert schedule as always on

The default setting of sensors' alert schedule is **Always on**. You will receive an announcement alert - "*Sensor X* is open*" or "*Motion X* sensor detected motion*", every time a monitored garage door, in-house door, window, or medicine cabinet is opened, or there is motion in the monitored area.

You can also set a reminder in case you forget to close the monitored object. You can choose to receive an alert once again if it remains open after 15, 30, or 60 minutes.

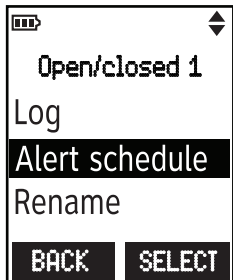

1. Press **SENSORS** on the handset or telephone base when idle, and then scroll to the desired sensor.

-OR-

- i. Press **MENU** on the handset or telephone base when idle.
 - ii. Scroll to **Sensors**, and then press **SELECT**.
 - iii. Scroll to the desired sensor, and then press **SELECT**.
2. Press **OPTIONS** to enter the individual sensor menu.
 3. Scroll to choose **Alert schedule**, and then press **SELECT**.
 4. Press **SELECT** to select **Always on**. The reminder menu appears.
 5. Scroll to choose **Off**, **15 minutes**, **30 minutes**, or **60 minutes**, and then press **SELECT** to save.

NOTES

- When you received the alert tone and announcement, the handset will display **Sensor X is open** or **Motion X detected motion**, whilst the telephone base will display **Sensor X is open** or **Motion X sensor detected motion**.
- For garage door sensor and open/closed sensor, both the handset and telephone base will also display , and the **SENSOR** light on the telephone base will turn red.

- * **Sensor X** or **Motion X** refer to the sensor's name.
X refers to the system-assigned number of the sensor. You can edit the sensor's name to your preferred name. See **Rename the sensor** on page 33.

Set a time range for alerts

You can choose to receive an announcement alert - “*Sensor X is open*” or “*Motion X sensor detected motion*”, when a monitored garage door, in-house door, window, or medicine cabinet is opened, or when there is motion in the monitored area, during a preset time period of the day. For example, you can set to receive alert only from 10pm to 6am during bedtime.

You can also set a reminder in case you forget to close the monitored object. You can also choose to receive an alert once again if it remains open after 15, 30, or 60 minutes.

1. Press **SENSORS** on the handset or telephone base when idle, and then scroll to the desired sensor.
-OR-
 - i. Press **MENU** on the handset or telephone base when idle.
 - ii. Scroll to **Sensors**, and then press **SELECT**.
 - iii. Scroll to the desired sensor, and then press **SELECT**.
2. Press **OPTIONS** to enter the individual sensor menu.
3. Scroll to choose **Alert schedule**, and then press **SELECT**.
4. Scroll to choose **Time range**, and then press **SELECT**.
 - If time range has been set previously, press **EDIT** to edit.
5. Use the dialing keys (**0-9**) to enter the hour and minute for the start time. Scroll to choose **AM** or **PM**, and then press **NEXT**.
6. Use the dialing keys (**0-9**) to enter the hour and minute for the end time. Scroll to choose **AM** or **PM**, and then press **SAVE**. The reminder menu appears.
7. Scroll to choose **Off**, **15 minutes**, **30 minutes**, or **60 minutes**, and then press **SELECT** to save.

NOTE

- Suppose you have set the time range from 10pm to 6am. When the time reaches 10pm, you will receive the alert once if the garage door, in-house door, window, or medicine cabinet is already open.

Turn off the alerts

You can choose not to receive an announcement alert when a monitored garage door, in-house door, window, or medicine cabinet is opened, or when there is motion in the monitored area.

If it is a monitored garage door, in-house door, window, or medicine cabinet that is opened, the  icon will still display on the handset and telephone base. The **SENSOR** light on the telephone base will also turn on.



1. Press **SENSORS** on the handset or telephone base when idle, and then scroll to the desired sensor.
-OR-
 - i. Press **MENU** on the handset or telephone base when idle.
 - ii. Scroll to **Sensors**, and then press **SELECT**.
 - iii. Scroll to the desired sensor, and then press **SELECT**.
2. Press **OPTIONS** to enter the individual sensor menu.
3. Scroll to choose **Alert schedule**, and then press **SELECT**.
4. Scroll to choose **Off**, and then press **SELECT** to save.

Alert notifications

You can choose the type of notification to receive when a sensor is triggered. The preset alert notification type is **LCD, tone, voice**.

Definitions of notification types:

Msg - The LCD display messages, **Sensor X is open** or **Motion X detected motion**, on the handset and telephone base.

Tone - The long alert tone that you will hear prior to the voice announcement and LCD display message.

Voice - The voice announcement, "*Sensor X is open*" or "*Motion X sensor detected motion*", at the handset and telephone base.

| Notification type | Alert tone | Voice announcement | LCD display message |  * | SENSOR light on base* | Event logged in sensor log |
|-------------------|------------|--------------------|---------------------|---|-----------------------|----------------------------|
| LCD, tone, voice | ✓ | ✓ | ✓ | ✓ | ✓ | ✓ |
| LCD & tone | ✓ | -- | ✓ | ✓ | ✓ | ✓ |
| LCD msg only | -- | -- | ✓ | ✓ | ✓ | ✓ |

1. Press **MENU** on the handset or telephone base when idle.
2. Scroll to **Sensor setup**, and then press **SELECT**.
3. Press **SELECT** to select **Notifications**, and then press **SELECT**.
4. Scroll to choose **LCD, tone, voice**, **LCD & tone** or **LCD Msg only**, and then press **SELECT** to save.

NOTE

- If the alert schedule of a sensor is set to **Off**, when the monitored garage door, in-house door, window, or medicine cabinet is opened, there will be no notifications except that the  icon will display on the handset and telephone base, and the **SENSOR** light on the telephone base will turn on.

*  and **SENSOR** light on the telephone base will not be displayed when motion sensor is triggered.

Test sensor signal strength

Before you mount the sensor, follow the instructions below to check the signal strength between the sensor and the telephone base. Make sure you mount the sensor in a location where the signal strength is good.

Using a handset:

1. Press **MENU** on the handset when idle.
2. Scroll to **Sensor setup**, and then press **SELECT**.
3. Scroll to **Check signal**, and then press **SELECT**.
4. Scroll to the sensor you want to test, and then press **SELECT**.
5. The screen displays **Test signal strength between base and sensor**. Press **NEXT**.
6. The screen displays **Please trigger your sensor now..** Trigger your sensor (refer to **Installation Guide**), and then press **NEXT**. The screen displays **Awaiting signal... Please wait**.
 - If the screen displays **No signal. Please try again..** Press **OK**, and then return to step 3 to test again.
 - If the screen displays **Weak signal Move sensor closer to base.,** adjust the sensor's location to improve the signal, and then press **NEXT**.
7. When the screen displays **Good signal. Good location for sensor..** Press **OK**. The testing is complete.

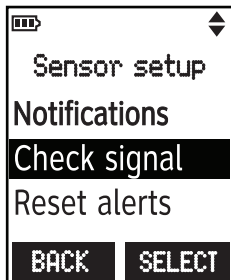

Rename the sensor

You can create a customized name of up to 15 characters for each sensor. The new name will also be announced in announcement alerts.

1. Press **SENSORS** on the handset or telephone base when idle, and then scroll to the desired sensor.

-OR-

- i. Press **MENU** when the phone is not in use.
 - ii. Scroll to **Sensors**, and then press **SELECT**.
 - iii. Scroll to the desired sensor, and then press **SELECT**.
2. Press **OPTIONS** to enter the individual sensor menu.
 3. Scroll to **Rename**, and then press **SELECT**.
 4. Use the dialing keys to edit the name, and then press **SAVE** to save.

Reset sensor alerts

You can reset the alert schedule of all individual sensors' to their default settings - **Always on**. The sensor notification type will also be reset to its default setting - **Msg, tone, voice**.

1. Press **MENU** on the handset or telephone base when idle.
2. Scroll to **Sensor setup**, and then press **SELECT**.
3. Scroll to **Reset alerts**, and then press **SELECT**.
4. The screen displays **Reset all sensor alert settings to Always on?**. Press **YES**.
5. The screen displays **All sensors alerts are set to always on**, and then will return to the previous screen.

NOTES

- If you have renamed the sensor(s), the name(s) will not be reset to default.
- The current sensor mode will remain unchanged after reset.

Sensor log

The sensor log menu appears when there is at least one sensor registered to the telephone base.

The sensor log stores a maximum of 50 entries for the sensor activities from all sensors.

1. Press **MENU** on the handset or telephone base when idle.
2. Scroll to **Sensor log**, and then press **SELECT** to review the sensor log.
 - To delete a sensor log entry, press **DELETE**.
 - To delete all sensor log entries, press **DEL ALL**, and then **YES** to confirm. The screen will display **No alerts**.

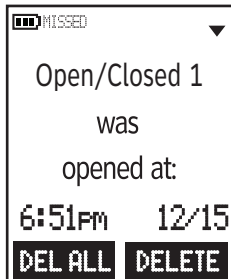

Individual sensor's log:

You can also access each individual sensor's log for the sensor activities of a single sensor.

1. Press **SENSORS** on the handset or telephone base when idle, and then scroll to the desired sensor.
-OR-
 - i. Press **MENU** on the handset or telephone base when idle.
 - ii. Scroll to **Sensors**, and then press **SELECT**.
 - iii. Scroll to the desired sensor, and then press **SELECT**.
2. Press **OPTIONS** to enter the individual sensor menu.
3. Press **SELECT** to select **Log** to review the sensor log.
 - To delete a sensor log entry, press **DELETE**.
 - To view the next sensor log entry, press **NEXT**.

Configure your telephone

Using the menus

1. Press **MENU** on the handset or telephone base when idle.
2. Scroll until the screen displays the desired feature menu.
3. Press **SELECT** to enter that menu.
 - To return to the previous menu, press **CANCEL**.
 - To return to idle mode, press and hold **CANCEL**.



Set language

The LCD language is preset to English. You can select English, French, or Spanish to be used in all screen displays.

1. Press **MENU** on the handset or telephone base when idle.
2. Scroll to **Phone setup**, then press **SELECT**.
3. Press **SELECT** to select **LCD language**.
4. Scroll to highlight **English**, **Français**, or **Español**, then press **SELECT**.
5. Press **YES** to save your preference.
-OR-
Press **NO** to cancel the operation.

NOTE

- If you accidentally changed the LCD language to French or Spanish, you can reset it to English easily by pressing **MENU** and then entering ^{tone}***364#**.

Set date and time



- Make sure you set the date and time including the year correctly; otherwise the answering system does not announce the correct day of the week for your recorded messages time stamp.
1. Press **MENU** on the handset or telephone base when idle.
 2. Scroll to **Set date/time**, and then press **SELECT**.
 3. Use the dialing keys (**0-9**) to enter the month, date, and year, and then press **NEXT**.
 4. Use the dialing keys (**0-9**) to enter the hour and minute. Scroll to choose **AM** or **PM**, and then press **SAVE** to save.

Temporary tone dialing

If you have pulse (rotary) service only, you can switch from pulse to tone dialing temporarily during a call.

1. During a call, press ***_{tone}**.
2. Use the dialing keys to enter the relevant number.

The telephone sends touch-tone signals. It automatically returns to pulse dialing mode after you end the call.

Quiet mode

You can turn on the quiet mode for a period of time. During this period, all tones (except paging tone) and call screening are muted. When you turn on the quiet mode, the answering system turns on automatically.

1. Press and hold **#_{quiet}** on the handset or telephone base when idle.
2. Use the dialing keys (**0-9**) to enter the duration, and then press **SELECT** to save.



NOTES

- To turn off the quiet mode, press and hold #quiet on the handset or telephone base when idle.
- Sensor alert tone and announced alert will not be silenced in quiet mode.

Caller ID announce

The caller ID announce feature lets you know who's calling without having to look at the display. When you have an incoming call, the handset speaks "Call from..." and the name of the caller based on the phonebook or caller ID information. If the caller's name is private or unknown, the phone number up to the last 11 digits will be announced. If the caller's phone number is also private or unknown, no information will be announced.

1. Press **MENU** on the handset or telephone base when idle.
2. Scroll to **Caller ID annc**, and then press **SELECT**.
3. Scroll to choose **On** or **Off**, and then press **SELECT** to save.

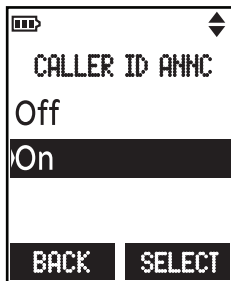

NOTES

- To use the caller ID announce feature, you must subscribe to caller ID service from your telephone service provider.
- When there are more than four handsets registered, the telephone system supports caller ID announce for the first four registered handsets only.



Use caller ID to automatically set date and time

If you subscribe to caller ID service, the month, day, and time are set automatically with each incoming call. Follow the steps below to turn the **CID time sync** feature on or off. The default setting is **On**.



1. Press **MENU** in idle mode to enter the main menu.
2. Scroll to **Phone setup**, then press **SELECT**.
3. Scroll to **CID time sync**, then press **SELECT**.
4. Scroll to highlight **On** or **Off**, then press **SELECT** to save. There is a confirmation tone and the screen returns to the previous menu.

Telephone operations



Make a call

- Press  or  on the handset, or press  on the base, and then dial the telephone number.

-OR-

- Enter the telephone number on the handset or base, and then press  or  on the handset, or press  on the base, to dial.

Answer a call

- Press  or  on the handset,  on the base, or any dialing key (**0-9**, or *** tone**).

End a call

- Press **OFF** on the handset, or put the handset to the base or charger.

-OR-

- Press  on the base.

Handset speakerphone

- During a call, press  on the handset to switch between speakerphone and normal handset use.

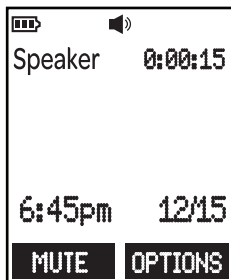
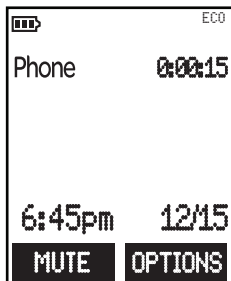

Volume

- During a call, press **∨/VOLUME/∧** on the handset or **▲/VOL/▼** on the telephone base to adjust the listening volume.

NOTE

- The volume settings of handset earpiece, handset speakerphone, and telephone base speakerphone are independent.

Mute

The mute function allows you to hear the other party but the other party cannot hear you.

1. During a call, press **MUTE** on the handset or telephone base. The screen displays **Muted**.
2. Press **MUTE** again to resume the conversation. The screen displays **Microphone ON**.

Call waiting

When you subscribe to call waiting service from your telephone service provider, you hear an alert tone if there is an incoming call while you are on another call.

- Press **FLASH** to put the current call on hold and take the new call.
- Press **FLASH** to switch back and forth between calls.

Find handset

Use this feature to find all system handsets.

To start paging:

- Press **[FIND HANDSET]** on the base. All idle handsets ring and display **** Paging ****.

To mute paging:

- Press **[MUTE]**, **[MUTE]**, **[CANCEL]**, or **[#quiet]** on the handset.

To end paging:

- Press **[FIND HANDSET]** or **[STOP]** on the base.

-OR-

- Press **[TALK FLASH]**, **[MUTE]**, or any dialing key on the handset.

NOTE

- Do not press and hold **[FIND HANDSET]** for more than four seconds. It may lead to handset deregistration.



Redial list

The base and each handset store the last 10 telephone numbers dialed. When there are already 10 entries, the oldest entry is deleted to make room for the new entry.

To review and dial a number from the redial list:



1. Press **[REDIAL]** on the handset or telephone base when idle.
2. Scroll or press **[REDIAL]** repeatedly until the desired entry displays.
3. Press **[TALK FLASH]** or **[MUTE]** on the handset, or press **[SPEAKER]** on the base, to dial.

To delete a redial entry:

When the desired redial entry displays, press **[DELETE]**.

Join a call in progress

You can use up to two handsets plus the base at a time on a call. You can buy additional expansion handsets for this telephone base. You can register up to 5 handsets to the telephone base.

- When a handset is on a call, press  or  on another handset to join the call.
- Press **OFF** on the handset or  on the base to exit the call. The call continues until all handsets hang up.

Push-to-talk (PTT)

You can directly broadcast messages from one handset to the speakerphone of one or multiple devices. Up to four handsets can join in a PTT call.

To start a PTT communication:

1. Press **PUSH TO TALK** on the handset or **PTT** on the base when idle.
2. Scroll to a desired device or **Group**, and then press **SELECT**.



NOTES

- Only one device can talk at a time.
- Press and hold **PUSH TO TALK** while you are talking. Release **PUSH TO TALK** to let the other party respond.
- When there are 5 devices on the PTT at the same time, you will not receive any voice announcement alert from sensors.



Intercom

Use the intercom features for conversations between the telephone base and handsets.



1. Press **MENU** on the handset or telephone base when idle.
2. Scroll to **Intercom** and then press **SELECT**.
3. Use the dialing keys to enter a destination handset or base number.
4. To answer the intercom call, press , , or **ANSWER** on the handset; or  or **ANSWER** on the base; or any dialing key on the destination handset or base.
5. To end the intercom call, press **END**.

NOTE

- When there are 5 devices on intercom at the same time, you will not receive any voice announcement alert from sensors.

Transfer a call

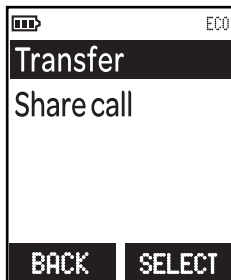

While on an outside call, you can use the intercom feature to transfer the call from one handset to another.

1. Press **OPTIONS** on the handset or telephone base during a call.
2. Press **SELECT** to choose **Intercom**. Use the dialing keys to enter a destination device number. The current call is put on hold.
3. To answer the intercom call, press  **TALK FLASH**, , or **ANSWER** on the handset; or  or **ANSWER** on the base; or any dialing key on the destination device. You can now have a private conversation before transferring the call.
4. To transfer the call, press **OPTIONS** on the initiating device, and then press **SELECT** to select **Transfer**.



Answer an incoming call during an intercom call

If you receive an incoming call during an intercom call, there is an alert tone.

- To answer a call, press  **TALK FLASH** or  on the handset, or press  on the base. The intercom call ends automatically.
- To end the intercom call without answering the outside call, press **BACK** and then **END**. The intercom call ends and the telephone continues to ring.

Phonebook

The phonebook stores up to 50 entries with up to 30 digits for each phone number and 15 characters for each name.

Add a phonebook entry

1. Press **MENU** on the handset or telephone base when idle.
2. Scroll to **Phonebook**, and then press **SELECT**.
3. Scroll to **Add contact**, and then press **SELECT**.
4. Use the dialing keys to enter the number (up to 30 digits), and then press **NEXT**.
5. Use the dialing keys to enter the name (up to 15 characters). Additional key presses show other characters of that particular key.
6. Press **SAVE** to save.







While entering numbers and names, you can:

- Press **DELETE** to erase a digit or character.
- Press and hold **DELETE** to erase the entire entry.
- Scroll to move the cursor to the left or right.
- Press and hold **PAUSE** to insert a dialing pause (for entering phone numbers only).
- Press **0** to add a space (for entering names only).
- Press ***^{tone}** to add * or **#^{tone}** to add # (for entering phone numbers only).
- Press ***^{tone}** to change the next letter to upper or lower case.

Review and dial from the phonebook

Entries are sorted alphabetically.

1. Press  on the handset or **PHONEBOOK/▲** on the telephone base when idle.
2. Scroll to browse through the phonebook, or use the dialing keys to start a name search
3. When the desired entry appears, Press  or  on the handset, or press  on the base to dial.



Edit a phonebook entry

1. When the desired entry displays, press **EDIT**.
2. Use the dialing keys and **BACKSP** to edit the number, and then press **NEXT**.
3. Use the dialing keys to edit the name, and then press **SAVE** to save.

Delete a phonebook entry

1. When the desired entry displays, press **DELETE**.
2. When the screen displays **Delete contact?**, press **YES** to confirm delete.

Caller ID

This product supports caller ID services provided by most telephone service providers. Depending on your service subscription, you may see the caller's name, number, date and time of calls that are sent by your telephone service provider after the first or second ring.

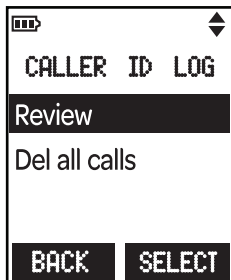



Caller ID log

The caller ID log stores up to 50 entries. If you answer a call before the caller information appears, it will not be saved in the caller ID log.

- The screens display **XX Missed calls** when there are new missed calls in the caller ID log.
- If you want to erase the missed call indicator, press and hold CANCEL or press **CID** when idle.



Review and dial a number in the caller ID log

1. Press **CID** or **CALLER ID/▼** when idle.
2. Scroll to browse through the caller ID log. When the desired entry appears:
 - Press **#** repeatedly to show different dialing options.
 - Press **1** repeatedly if you need to add or remove 1 in front of the phone number.
3. Press  or  on the handset, or press  on the base to dial the displayed number.

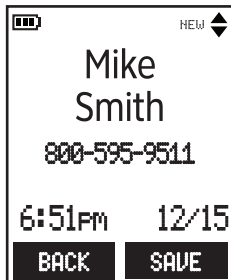

Save a caller ID log entry to the phonebook

1. When the desired caller ID log entry displays, press **SAVE**.
2. Press **SELECT** to select **Phonebook**.
3. Use the dialing keys and **BACKSP** to edit the number, and then press **NEXT**.
4. Use the dialing keys to edit the name, and then press **SAVE** to save.

Delete a caller ID log entry

- When the desired caller ID log entry displays, press **DELETE**.

Delete all caller ID log entries

1. Press **MENU** on the handset or telephone base when idle.
2. Scroll to **Caller ID log** and then press **SELECT**.
3. Scroll to **Del all calls** and then press **SELECT**.
4. When the screen displays **Delete all calls?**, press **YES** to confirm delete.

Call block

If you subscribe to caller ID service, you can set the telephone to block unknown calls and certain undesired calls.

The call block list stores up to 20 entries.

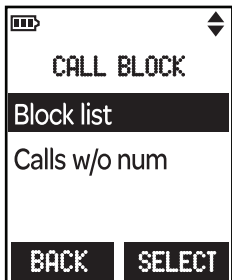

Block unknown calls

1. Press **MENU** when the phone is not in use.
2. Scroll to **Call block**, and then press **SELECT**.
3. Scroll to **Calls w/o num**, and then press **SELECT**.
4. Scroll to choose **Block** or **Unblock**, and then press **SELECT**.



Add a call block list entry

1. Press **MENU** when the phone is not in use.
2. Scroll to **Call block**, and then press **SELECT**.
3. Press **SELECT** to select **Block list**.
4. Scroll to **Add new entry**, and then press **SELECT**.
5. Enter the number.
 - Use the dialing keys to enter the number (up to 30 digits).

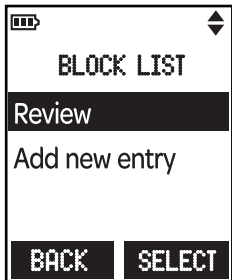

6. Press **NEXT** to move to the name.
7. Use the dialing keys to enter the name (up to 15 characters). Additional key presses show other characters of that particular key.
8. Press **SAVE** to save.

Review the call block list

1. Press **MENU** when the phone is not in use.
2. Scroll to **Call block**, and then press **SELECT**.
3. Press **SELECT** to select **Block list**.
4. Press **SELECT** to choose **Review**.
5. Scroll to browse through the call block list.

Edit a call block list entry

1. When the desired entry displays, press **EDIT**.
2. Use the dialing keys to edit the number, and then press **NEXT**.
3. Use the dialing keys to edit the name, and then press **SAVE** to save.

Save a caller ID log entry to call block list

1. When the desired caller ID log entry displays, press **SAVE**.
2. Scroll to **Call block** then press **SELECT**.
3. Use the dialing keys and **BACKSP** to edit the number, and then press **NEXT**.
4. Use the dialing keys to edit the name, and then press **SAVE** to save.

Delete a call block list entry

1. When the desired call block list entry displays, press **DELETE**.
2. When the screen displays **Delete entry?**, press **YES** to confirm delete.

Sound settings

Key tone

You can adjust the key tone volume, or turn the key tone off.

1. Press **MENU** when the handset is not in use.
2. Scroll to **Phone setup**, and then press **SELECT**.
3. Scroll to choose **Key tone**, and then press **SELECT**.
4. Scroll to choose the desired volume or **Off**, and then press **SET** to save.

Ringer tone

You can choose from different ringer tones.

1. Press **MENU** on the handset or telephone base when idle.
2. Scroll to **Ringers**, and then press **SELECT**.
3. Scroll to **Ringer tone**, and then press **SELECT**.
4. Scroll to sample each ringer tone, and then press **SELECT** to save.

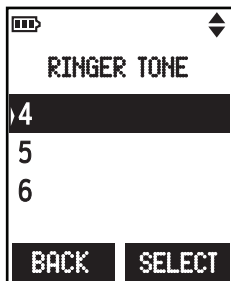

NOTE

- If you turn off the ringer volume, you will not hear ringer tone samples.

Ringer volume

You can adjust the ringer volume level, or turn the ringer off.

To adjust the handset ringer volume:

1. Press **MENU** on the handset when idle.
2. Scroll to **Ringers**, and then press **SELECT**.
3. Press **SELECT** to select **Ringer volume**.
4. Scroll to adjust the volume, and then press **SET** to save.

NOTE

- If the handset ringer volume is set to off, the handset is silenced for all incoming calls except paging tone.



To adjust the telephone base ringer volume:

Press **▲/VOL/▼** on the telephone base when idle.

Temporary ringer silencing

When the telephone is ringing, you can temporarily silence the ringer without disconnecting the call. The next call rings normally at the preset volume.

- Press **MUTE**, **MUTE**, **CANCEL**, or **#quiet** on the handset or telephone base. The screen displays .

About the built-in answering system and voicemail service

For message recording, your telephone has a built-in answering system, and it also support voicemail service offered by your telephone service provider (subscription is required, and fee may apply).

The main differences between them are as follows:

| Category | Built-in answering system | Voicemail from telephone service |
|-----------------------------|---|---|
| Storage | Messages are stored in the telephone base. | Messages are stored in a server or system provided by your telephone service. |
| | Your messages will not be deleted automatically. You have to delete your messages manually. | Your messages may be automatically deleted after a period of time. Contact your telephone service provider for more details. |
| Method to retrieve messages | When you received new messages, OO displays on both the handset and telephone base, XX New msgs displays on the handset, and XX New messages displays on the telephone base. | When you received new messages, the handset displays ✉ and New voicemail . |
| | To retrieve messages, usually there are two ways: <ul style="list-style-type: none">• Press a button on the telephone base; or• Access remotely with an access code. | To retrieve messages, you need an access number and/or a passcode provided by your telephone service provider. |

Set your built-in answering system

Your answering system has various features, read below for the basic settings.

The answering system can record and store up to 99 messages. Each message can be up to three minutes in length. The total storage capacity for the announcement, messages and memos is approximately 22 minutes. The actual recording time depends on individual message characteristics.

Your answering system allows you to set your announcement, to save and delete messages, activate call screening, to set number of rings before pick up, to access remotely, and to control the recording time.

Turn the answering system on or off

The answering system must be turned on to answer and record messages.

Using the telephone base:

- Press **ANS ON/OFF** on the telephone base to turn the built-in answering system on or off.

-OR-

1. Press **MENU** when the phone is not in use.
2. Press **SELECT** to select **Answering sys.**
3. Scroll to highlight **Answer ON/OFF**, and then press **SELECT**.
4. Scroll to highlight **On** or **Off**, and then press **SELECT** to save. You hear a confirmation tone.



Using the handset:

1. Press **MENU** when the phone is not in use.
2. Scroll to highlight **Answering sys.**, and then press **SELECT**.
3. Scroll to highlight **Answer ON/OFF**, and then press **SELECT**.
4. Scroll to highlight **On** or **Off**, and then press **SELECT** to save. You hear a confirmation tone.

Default announcement

The telephone is preset with a greeting that answers calls with “*Hello, please leave a message after the tone.*” You can use this preset announcement, or replace it with your own.

Record your own announcement

You can use the preset announcement to answer calls, or replace it with your own recorded announcement. It can be up to 90 seconds in length.

1. Press **MENU** on the handset or telephone base when idle.
2. Scroll to **Answering sys** and then press **SELECT**.
3. Press **SELECT** to select **Announcement**.
4. Press **SELECT** to select **Record annc.**
5. The handset or telephone base announces “*Record after the tone. Press STOP when you are done.*” After the tone, speak towards the microphone. Press **STOP** when done.



Play the announcement

1. Press **MENU** on the handset or telephone base when idle.
2. Scroll to **Answering sys** and then press **SELECT**.
3. Press **SELECT** to select **Announcement**.
4. Scroll to **Play annc** and then press **SELECT**.

Reset the announcement

1. Press **MENU** on the handset or telephone base when idle.
2. Scroll to **Answering sys** and then press **SELECT**.
3. Press **SELECT** to select **Announcement**.
4. Scroll to **Reset annnc** and then press **SELECT**.
5. Press **YES** to reset to the default announcement.

Set number of rings

You can set the answering system to answer an incoming call after 2, 3, 4, 5 or 6 rings; or toll saver. If you choose toll saver, the answering system answers after 2 rings when you have new messages, or after 4 rings when you have no new messages.

1. Press **MENU** on the handset or telephone base when idle.
2. Scroll to **Answering sys** and then press **SELECT**.
3. Scroll to **Ans sys setup** then press **SELECT**.
4. Scroll to **# of rings** then press **SELECT**.
5. Scroll to choose **6, 5, 4, 3, 2** or **Toll saver**, and then press **SELECT**.

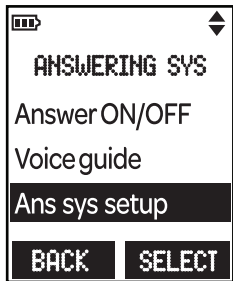

Message alert tone

When the message alert tone is set to on, and there is at least one new message, the telephone base beeps every 10 seconds. The message alert tone is preset to off.

1. Press **MENU** when the phone is not in use.
2. Scroll to **Answering sys** and then press **SELECT**.
3. Scroll to **Ans sys setup** then press **SELECT**.
4. Scroll to **Msg alert tone** then press **SELECT**.
5. Scroll to choose **On** or **Off**.
6. Press **SELECT** to save and you hear a confirmation tone.

Recording time

You can set the recording time limit for each incoming message.

1. Press **MENU** when the phone is not in use.
2. Scroll to **Answering sys** and then press **SELECT**.
3. Scroll to **Ans sys setup** then press **SELECT**.
4. Scroll to **Recording time** then press **SELECT**.
5. Scroll to choose **3 minutes**, **2 minutes** or **1 minute**.
6. Press **SELECT** to save and you hear a confirmation tone.

Voice guide

This feature is an alternative way for you to do the basic setup of the answering system. You can follow the voice guide to record your own announcement, set the number of rings and the message alert tone.

1. Press **MENU** when the phone is not in use.
2. Scroll to **Answering sys** and then press **SELECT**.
3. Scroll to highlight **Voice guide**, and then press **SELECT**. You hear the voice prompt *"Hello! This voice guide will assist you with the basic setup of your answering system."*
4. Setup your answering system by inputting designated numbers as instructed in the voice guide.

Use your built-in answering system

New message indication

When you received a message on your answering system, **OO** displays on both the handset and telephone base, **XX New msgs** displays on the handset, and **XX New messages** displays on the telephone base. To retrieve, press **▶/■/PLAY** when the phone is not in use.



Message playback

To play messages at the telephone base:

- Press **▶/■/PLAY** when the phone is not in use.

Options during playback:

- Press **▲/VOL/▼** to adjust the speaker volume.
- Press **▶/SKIP** to skip to the next message.
- Press **◀/REPEAT** to repeat the message currently playing. Press **◀/REPEAT** twice to listen to the previous message.
- Press **X/DELETE** to delete the playing message. The system advances to the next message.
- Press **▶/■/STOP** to stop.
- Press **📞** to call back the caller if the message contains caller ID information. The telephone base screen displays **Call back?** with the caller ID information.
 - Press **CALL** to call back the caller.
 - Press **BACK** to restart the message playback.



To play messages at the handset:

1. Press **MENU** when the handset is not in use.
2. Scroll to **Play messages**, and then press **SELECT**.
 - If there are new and old messages, press **▼** or **▲** to select **Play new msgs** or **Play old msgs**, then press **SELECT**.
 - If there are only new or only old messages, they will play automatically.



The system announces the number of messages, then begins playback. The message sequence is shown on the handset. If there are no recorded messages, the handset shows **No messages** and you hear, "You have no messages."

Options during playback:

- Press **VOLUME**  or **VOLUME**  to adjust the message playback volume.
- Press **SKIP** to skip to the next message.
- Press **REPEAT** to repeat the message. Press **REPEAT** twice to listen to the previous message.
- Press **DELETE** to delete the message.
- Press  to call back the caller if the message contains caller ID information. The telephone base screen displays **Call back?** with the caller ID information.
 - Press **CALL** to call back the caller.
 - Press **BACK** to restart the message playback.

NOTES

- Only one handset or the telephone base can access the answering system at a time.
- During message playback, if there is an incoming call or another handset makes a call, message playback will be stopped.

Delete all old messages



To delete all old messages at the telephone base:

Press **X/DELETE** twice when the phone is not in use.

To delete all old messages on a handset:

1. Press **MENU** when the phone is not in use.
2. Scroll to **Answering sys** and then press **SELECT**.
3. Scroll to **Delete all old**, and then press **SELECT**.
4. Press **YES** to confirm delete. You hear a confirmation tone.

Call intercept

If you want to talk to the person whose message is being recorded, press  or  on the handset, or press  on the base.

Remote access

A two-digit security code is required to access the messages, or change the sensor mode setting remotely, from any touch-tone telephone. The preset code is **19**. You can use this preset code, or set your own.

1. Dial your telephone number from any touch-tone telephone.
2. When the system plays your announcement, enter the two-digit security code.
3. Enter the one of the remote commands, # or *, to listen to message or change the sensor mode .

| Command | Description |
|---------|--|
| # | To listen to messages (see page 60). |
| * | To change the sensor mode (see page 61). |

Listen to messages from remote access

1. Follow steps 1 and 2 in **Remote access** section on page 59 to enter remote access mode.
2. Press # on your remote touch-tone telephone to enter the answering system operations command session.
3. You can enter one of the following remote commands to do the answering system operations.

| Command | Description |
|---------|---|
| 1 | Play all messages. |
| 2 | Play new messages. |
| 3 | Delete the current message (during playback). |
| 33 | Delete all old messages. |
| 4 | Repeat the current message (during playback). |
| 5 | Stop. |
| *5 | Hear a list of remote commands. |
| 6 | Skip to the next message (during playback). |
| *7 | Record a new announcement. |
| 8 | End the call. |
| 0 | Turn the answering system on or off. |

4. Hang up or press **8** to end the call.

Change sensor mode from remote access

1. Follow steps 1 and 2 in **Remote access** section on page 59 to enter remote access mode.
2. Press * on your remote touch-tone telephone to enter the sensor mode command session.
3. You can enter one of the following remote commands to change to the respective sensor mode.

| Command | Description |
|---------|------------------------------------|
| 1 | Change to Local mode. |
| 2 | Change to Remote mode. |
| 3 | Turn off all alerts in local mode. |

NOTE

- Changing the sensor mode in remote access from **Local** to **Remote**, or vice versa, will automatically set the sensor alert system to be **Armed**.

Remote access code

A two-digit security code is required to access the answering system remotely from any touch-tone telephone. The preset code is **19**. You can set the code from **00** to **99**.

1. Press **MENU** when the phone is not in use.
2. Scroll to **Answering sys** and then press **SELECT**.
3. Scroll to **Ans sys setup** then press **SELECT**.
4. Scroll to **Remote code**, and then press **SELECT**.
5. Use the dialing keys to enter a two-digit number.
6. Press **SAVE** to save and you hear a confirmation tone.

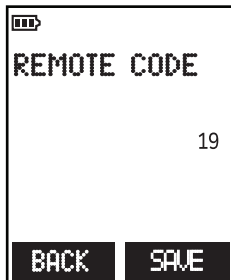

Use the built-in answering system and voicemail service

You can use your answering system and voicemail service together by setting your answering system to answer before voicemail service answers as described below. To learn how to program your voicemail settings, contact your telephone service provider.

If you are on a call, or if the answering system is busy recording a message and you receive another call, the second caller can leave a voicemail message.

Set your answering system to answer calls at least two rings earlier than your voicemail service is set to answer. For example, if your voicemail service answers after six rings, set your answering system to answer after four rings.

Some voicemail service providers may program the delay before answering calls in seconds instead of rings. In this case, allow six seconds per ring when determining the appropriate setting.

Retrieve voicemail from telephone service

Retrieve voicemail

When you received a voicemail, the handset displays  and **New voicemail**. To retrieve, you typically dial an access number provided by your telephone service provider, and then enter a security code. Contact your telephone service provider for instructions on how to configure the voicemail settings and listen to messages.

NOTE

- After you have listened to all new voicemail messages, the indicators on the handset turn off automatically.

Set your voicemail number

You can save your access number on each handset for easy access to your voicemail.

After you saved the voicemail number, you can press and hold 1 to retrieve voicemail.

1. Press **MENU** when the handset is not in use.
2. Scroll to **Phone setup**, and then press **SELECT**.
3. Scroll to **Voicemail #**, and then press **SELECT**.
4. Use the dialing keys to enter the voicemail number (up to 30 digits).
5. Press **SAVE** to save.



Turn off the new voicemail indicators

If you have retrieved your voicemail while away from home, and the handset still displays the new voicemail indicators, use this feature to turn off the indicators.

NOTE

- This feature turns off the indicators only, it does not delete your voicemail messages.

1. Press **MENU** when the handset is not in use.
2. Scroll to **Phone setup**, and then press **SELECT**.
3. Scroll to **Clear voicemail**, and then press **SELECT**.
4. Press **YES** to confirm.

Expand your telephone system

You can add new DECT 6.0 cordless handset (**VC7100**) (purchased separately) to your telephone system. This telephone system accommodates up to five DECT cordless handset.

You can also add new ULE garage door sensor (**VC7001**), open/closed sensor (**VC7002**), or motion sensor (**VC7003**) to your telephone system (all purchased separately). You can register up to 400 ULE sensors to the telephone base.

To enter registration mode on the telephone base for handset:

- Press and hold /FIND HANDSET on the telephone base for about 4 seconds when the phone is not in use. The telephone base shows **Registering... Please wait**.

Refer to the online User's manual of **VC7151/VC7152**, or the User's manual that comes with your **VC7100** new cordless handset, to register it to the telephone base.

To enter the registration mode on the telephone base for sensors:

1. Press **MENU** on the telephone base when idle.
2. Scroll to **Sensor setup**, and then press **SELECT**.
3. Scroll to **Add new sensor**, and then press **SELECT**. The screen displays **For sensor pairing process, see manual**.
4. Press **NEXT** after you initiated the pairing process at your sensor.

Refer to the online User's manual of **VC7151/VC7152**, or the User's manual that comes with your new sensor, to register the sensor to the telephone base.

ECO mode

This power conserving technology reduces power consumption for optimal battery performance. The ECO mode activates automatically whenever the handset is synchronized with the telephone base.

General product care

Taking care of your telephone

Your cordless telephone contains sophisticated electronic parts, so it must be treated with care.

Avoid rough treatment

Place the handset down gently. Save the original packing materials to protect your telephone if you ever need to ship it.

Avoid water

Your telephone can be damaged if it gets wet. Do not use the handset outdoors in the rain, or handle it with wet hands. Do not install the telephone base near a sink, bathtub or shower.

Electrical storms

Electrical storms can sometimes cause power surges harmful to electronic equipment. For your own safety, take caution when using electrical appliances during storms.

Cleaning your telephone

Your telephone has a durable plastic casing that should retain its luster for many years. Clean it only with a dry non-abrasive cloth. Do not use dampened cloth or cleaning solvents of any kind.

Storage

When you are not going to use the handset for some time, remove the rechargeable battery from the handset. Store the handset, the charger and the adapter in a cool and dry place.

Frequently asked questions

Below are the questions most frequently asked about the cordless telephone. If you cannot find the answer to your question, visit our website at www.vtechphones.com or call **1 (800) 595-9511** for customer service.

| | |
|--|---|
| <p>My telephone does not work at all.</p> | <p>Make sure the telephone base is installed properly, and battery is installed and charged correctly. For optimum daily performance, return the handset to the telephone base after use.</p> <p>Make sure the handset has registered to the telephone base.</p> |
| <p>The display shows No line. I cannot get a dial tone.</p> | <p>Disconnect the telephone line cord from your telephone and connect it to another telephone. If there is no dial tone on that other telephone either, then the telephone line cord may be defective. Try installing a new telephone line cord.</p> <p>If changing telephone line cord does not help, the wall jack (or the wiring to this wall jack) may be defective. Contact your telephone service provider.</p> <p>You may be using a new cable or VoIP service, the existing telephone jacks in your home may no longer work. Contact your service provider for solutions.</p> |
| <p>I get noise, static, or weak signals even when I'm near the telephone base.</p> | <p>Move your phone to a higher location. The phone may have better reception in a high area.</p> <p>If you subscribe to digital subscriber line (DSL) high-speed Internet service through your telephone line, make sure you install a DSL filter (not included) between the telephone line cord and telephone wall jack. Contact your DSL service provider for more information.</p> <p>If other phones in your home are having the same problem, contact your telephone service provider (charges may apply).</p> |

| | |
|--|--|
| <p>The display shows To register HS, see manual to register. The handset does not work at all.</p> | <p>The handset is deregistered from the telephone base. Place the handset in the telephone base to register it back. The handset shows HANDSET X Registered and you hear a beep when the registration process completes. This process takes about 60 seconds to complete.</p> |
| <p>The display shows Low battery and  flashes.</p> | <p>Place the handset in the telephone base or charger for charging.</p> |
| <p>The display shows Replace batt in Sensor X.</p> | <p>You need to replace the sensor batteries as follows:</p> <ol style="list-style-type: none"> 1. Press and hold CANCEL on the handset or telephone base to erase the message. 2. Press the pair key on the sensor before replacing batteries. 3. Replace the batteries with new ones. |
| <p>The sensor does not work at all.</p> | <p>Make sure batteries are installed.</p> <p>Check if the SENSORS softkey is displayed on the idle screen of the telephone base or handset. If yes, press SENSORS and then scroll to check if the desired sensor is on the sensor list. If the desired sensor is not found, then it may be deregistered from the telephone base.</p> <ol style="list-style-type: none"> 1. Press MENU on the telephone base when idle. 2. Scroll to Sensor setup, and then press SELECT. 3. Scroll to Add new sensor, and then press SELECT. The screen displays For sensor pairing process, see manual. 4. Press NEXT after you initiated the pairing process at your sensor. <p>Refer to the online User's manual of VC7151/VC7152, or the User's manual that comes with your new sensor, to register the sensor to the telephone base.</p> <p>The sensor may be out of range. Move the sensor closer to the telephone base.</p> |

| | |
|--|--|
| <p>I cannot receive alerts when the monitored garage door, in-house door, window, or medicine cabinet is opened.</p> | <p>Make sure the sensor alert system is in armed mode and that AL or AR appears on the display. If the icon does not appear on the display, press ARM to turn on the sensor alert system.</p> <p>For various alerts behavior, please check the settings of alert notifications (page 31) and individual sensors' alert schedule (page 28 to 30).</p> |
| <p>I want to replace an old sensor with a new one.</p> | <p>To replace a sensor, you must deregister the registered sensor first, and then register the new sensor to your ULE compatible product.</p> <ol style="list-style-type: none"> 1. Press MENU when the phone is not in use. 2. Enter the code *33734# to access the DEREGISTER menu. 3. Scroll to Single sensor, and then press SELECT. 4. Scroll to the sensor you want to deregister, and then press SELECT. 5. Press YES to confirm the deregistration. <p>The telephone base shows SENSOR X is deregistered and you hear a beep when the deregistration process completes.</p> |
| <p>The answering system does not announce the correct day of the week for recorded messages time stamp.</p> | <p>Make sure you have set the date and time. See Configure your telephone section.</p> |
| <p>The answering system does not answer after correct number of rings or does not record messages.</p> | <p>Make sure the answering system is on. When the answering system is on, the telephone base and handset show ANS ON and the ⏻/ANS ON light on the telephone base is on.</p> <p>If toll saver is selected, the number of rings changes to two when there are new messages.</p> |
| <p>I accidentally set my LCD language to Spanish or French, and I don't know how to change it back to English.</p> | <p>While the handset is not in use, press MENU and then enter *364# to change the handset LCD language back to English.</p> |

Limited Warranty

What does this limited warranty cover?

The manufacturer of this VTech Product warrants to the holder of a valid proof of purchase (“Consumer” or “you”) that the Product and all accessories provided in the sales package (“Product”) are free from defects in material and workmanship, pursuant to the following terms and conditions, when installed and used normally and in accordance with the Product operating instructions. This limited warranty extends only to the Consumer for Products purchased and used in the United States of America and Canada.

What will VTech do if the Product is not free from defects in materials and workmanship during the limited warranty period (“Materially Defective Product”)?

During the limited warranty period, VTech’s authorized service representative will repair or replace at VTech’s option, without charge, a Materially Defective Product. If we repair the Product, we may use new or refurbished replacement parts. If we choose to replace the Product, we may replace it with a new or refurbished Product of the same or similar design. We will retain defective parts, modules, or equipment. Repair or replacement of the Product, at VTech’s option, is your exclusive remedy. VTech will return the repaired or replacement Products to you in working condition. You should expect the repair or replacement to take approximately 30 days.

How long is the limited warranty period?

The limited warranty period for the Product extends for ONE (1) YEAR from the date of purchase. If VTech repairs or replaces a Materially Defective Product under the terms of this limited warranty, this limited warranty also applies to the repaired or replacement Product for a period of either (a) 90 days from the date the repaired or replacement Product is shipped to you or (b) the time remaining on the original one-year warranty; whichever is longer.

What is not covered by this limited warranty?

This limited warranty does not cover:

1. Product that has been subjected to misuse, accident, shipping or other physical damage, improper installation, abnormal operation or handling, neglect, inundation, fire, water or other liquid intrusion; or

2. Product that has been damaged due to repair, alteration or modification by anyone other than an authorized service representative of VTech; or
3. Product to the extent that the problem experienced is caused by signal conditions, network reliability, or cable or antenna systems; or
4. Product to the extent that the problem is caused by use with non-VTech accessories; or
5. Product whose warranty/quality stickers, product serial number plates or electronic serial numbers have been removed, altered or rendered illegible; or
6. Product purchased, used, serviced, or shipped for repair from outside the United States of America or Canada, or used for commercial or institutional purposes (including but not limited to Products used for rental purposes); or
7. Product returned without a valid proof of purchase (see item 2 on the next page); or
8. Charges for installation or set up, adjustment of customer controls, and installation or repair of systems outside the unit.

How do you get warranty service?

To obtain warranty service in the United States of America, please visit our website at **www.vtechphones.com** or call **1 (800) 595-9511**. In Canada, go to **www.vtechcanada.com** or dial **1 (800) 267-7377**.

NOTE: Before calling for service, please review the user's manual - a check of the Product's controls and features may save you a service call.

Except as provided by applicable law, you assume the risk of loss or damage during transit and transportation and are responsible for delivery or handling charges incurred in the transport of the Product(s) to the service location. VTech will return repaired or replaced Product under this limited warranty. Transportation, delivery or handling charges are prepaid. VTech assumes no risk for damage or loss of the Product in transit. If the Product failure is not covered by this limited warranty, or proof of purchase does not meet the terms of this limited warranty, VTech will notify you and will request that you authorize the cost of repair prior to any further repair activity. You must pay for the cost of repair and return shipping costs for the repair of Products that are not covered by this limited warranty.

What must you return with the Product to get warranty service?

1. Return the entire original package and contents including the Product to the VTech service location along with a description of the malfunction or difficulty; and
2. Include a “valid proof of purchase” (sales receipt) identifying the Product purchased (Product model) and the date of purchase or receipt; and
3. Provide your name, complete and correct mailing address, and telephone number.

Other limitations

This warranty is the complete and exclusive agreement between you and VTech. It supersedes all other written or oral communications related to this Product. VTech provides no other warranties for this Product. The warranty exclusively describes all of VTech’s responsibilities regarding the Product. There are no other express warranties. No one is authorized to make modifications to this limited warranty and you should not rely on any such modification.

State/Provincial Law Rights: This warranty gives you specific legal rights, and you may also have other rights, which vary from state to state or province to province.

Limitations: Implied warranties, including those of fitness for a particular purpose and merchantability (an unwritten warranty that the Product is fit for ordinary use) are limited to one year from the date of purchase. Some states/provinces do not allow limitations on how long an implied warranty lasts, so the above limitation may not apply to you. In no event shall VTech be liable for any indirect, special, incidental, consequential, or similar damages (including, but not limited to lost profits or revenue, inability to use the Product or other associated equipment, the cost of substitute equipment, and claims by third parties) resulting from the use of this Product. Some states/provinces do not allow the exclusion or limitation of incidental or consequential damages, so the above limitation or exclusion may not apply to you.

Please retain your original sales receipt as proof of purchase.

Technical Specifications

Frequency control Crystal controlled PLL synthesizer

Transmit frequency 1921.536-1928.448 MHz

Channels 5

Sensor operating temperature 0°F (-18°C) to 130°F (55°C)

Nominal effective range Maximum power allowed by FCC and IC. Actual operating range may vary according to environment conditions at the time of use.

Power requirements Handset: 2.4V 400mAH 2xAAA Ni-MH battery
Telephone base: 6V DC @ 600mA
Charger: 6V DC @ 400mA
Sensor: 2xAAA batteries

Memory Phonebook:
50 memory locations, up to 30 digits and 15 characters

Caller ID log:
50 memory locations; up to 24 digits and 15 characters

Disclaimer

This product is not designed for security purposes. When properly installed and maintained, this product may in some cases reduce the risk of burglary, fire, robbery or other events occurring without providing an alarm. VTech is not responsible for losses, injury, or damage resulting from the use of this product.

This product is covered by U.S. Patent #8,825,043. Other patents may be pending.



Specifications are subject to change without notice.
© 2015 for VTech Communications, Inc.
All rights reserved. 09/15. VC715X_ACIB_V3.0
Document order number: 91-007931-020-100

